

 TiiTENT 
TB300



1. Content



All TB300 contents are in one carry-on bag.

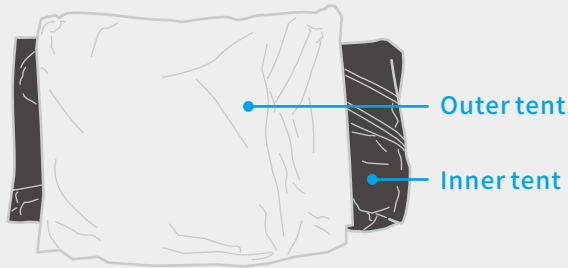

Peg Bag

Pole Bag



Minor pole
11mm 11-section
X 2



Main pole
13mm 12-section
X 2

To prevent breakage, make sure that the pole joints are firmly connected before proceeding.

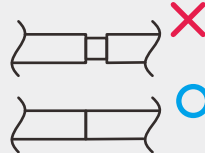

Pole: 7001 Aluminum Alloy

Material: Tear-resistant 75D Polyester with silicone treatment on the surface

Water pressure resistant: 3000mm

2. Dimension

Outer tent size

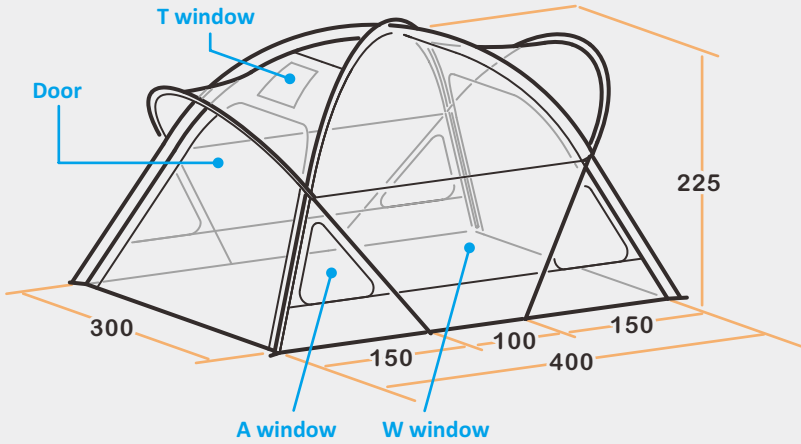

Inner tent size

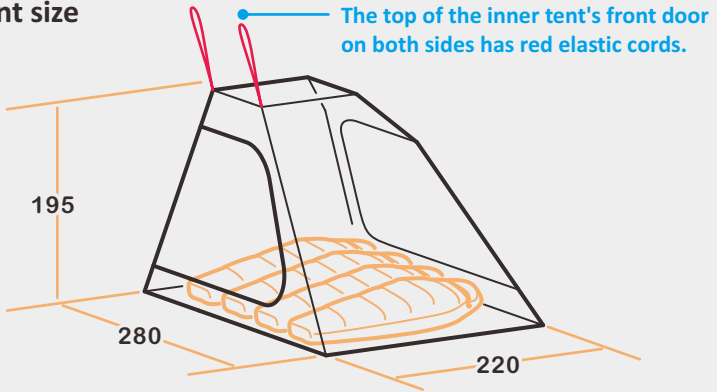

Inner tent and outer tent ratio diagram

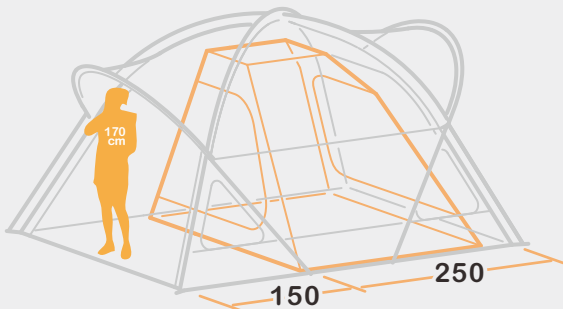

3. Set up the tent

- 1 Spread out the outer tent and lay it flat, find the X-shaped pole sleeve (red mark), and then insert the main pole (red mark) into the sleeve.

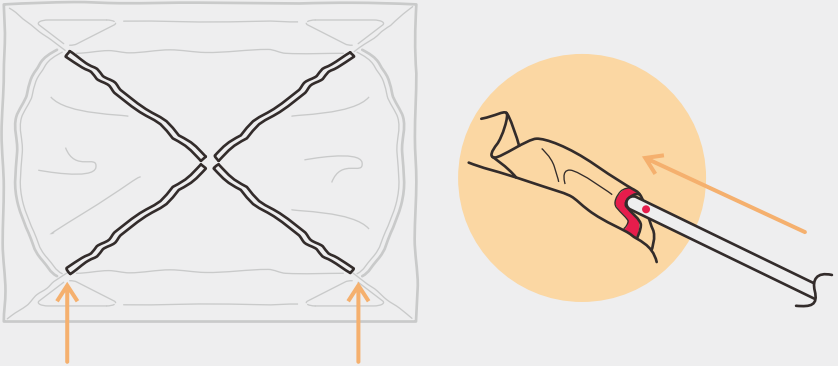

- 2 After both main poles are inserted into the pole sleeves, secure each end with the corresponding fork buckle and pole clip.

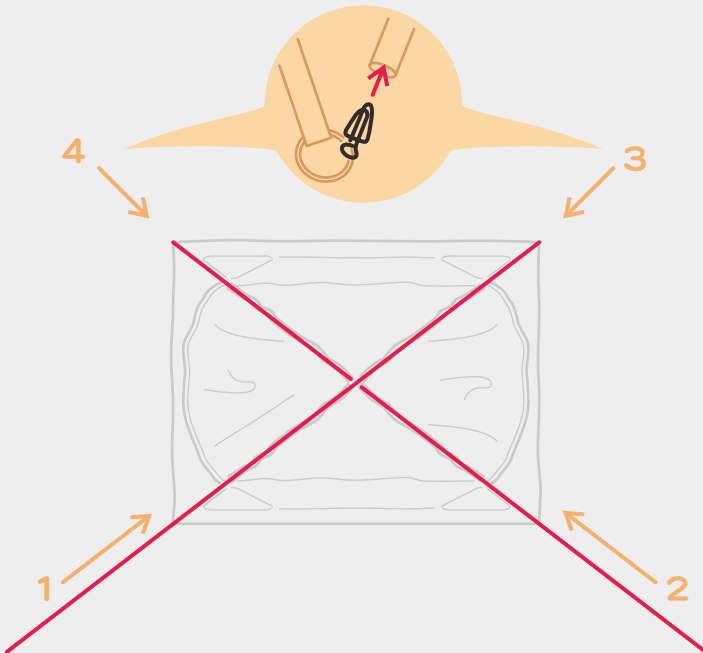

- 3 Next, arch one of the main poles and secure the other end of the main pole.

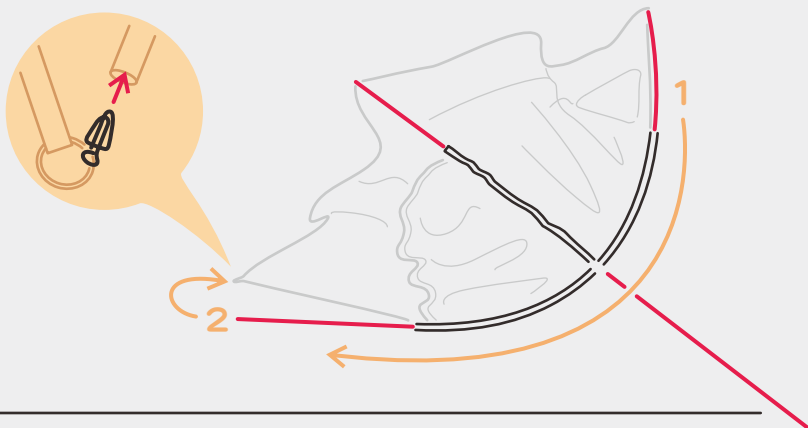

- 4 Finally, arch the other main pole. At this time, the outer tent will stand up at the same time. Then slowly make fine adjustments, and finally secure the pole and the fork buckle.

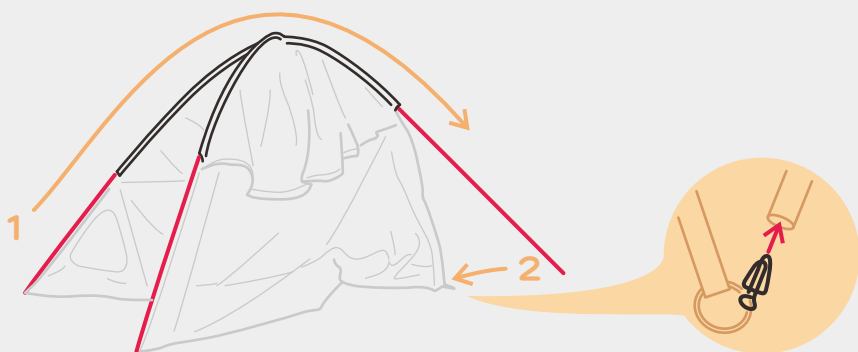

- 5 After the 2 main poles are assembled, the outer tent is now in a freestanding state. Slightly tidy up its appearance.

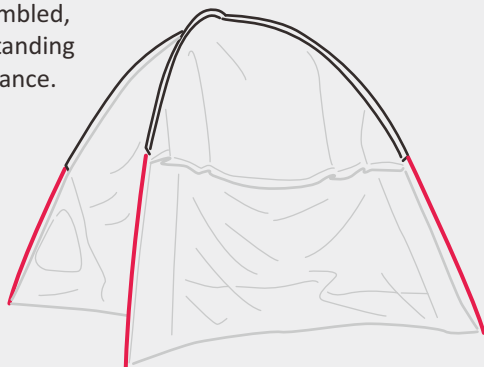

- 6 Pass the minor pole through the sleeve of the wing, and then connect both sides of the minor pole with the fork buckle.

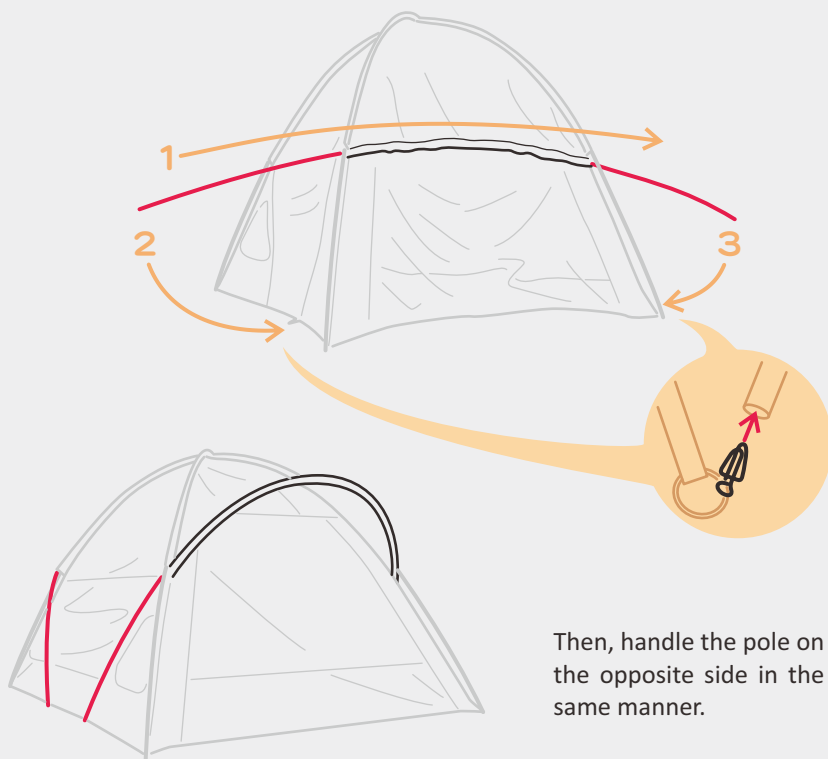

- 7 Secure all pole clips on the poles.

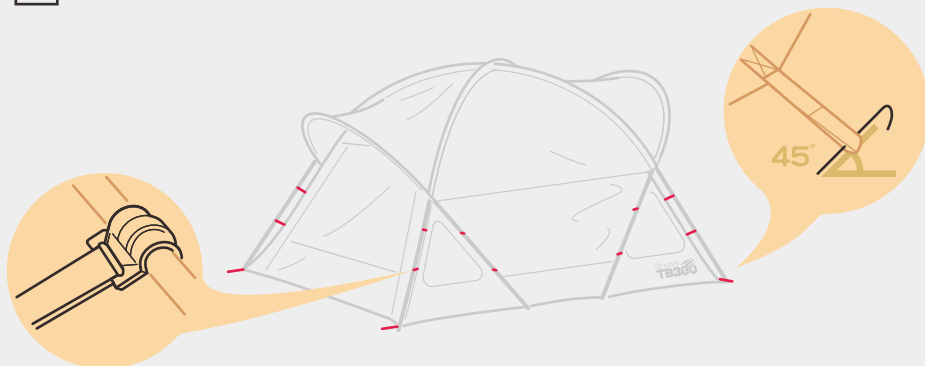

- 8 Use pegs to secure the four corners.

- 9** First wrap a strap around the intersection of the poles, then stake down the wind ropes.

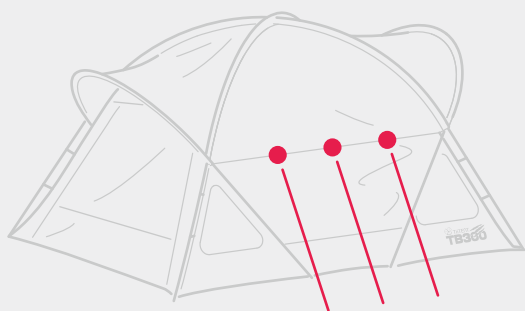
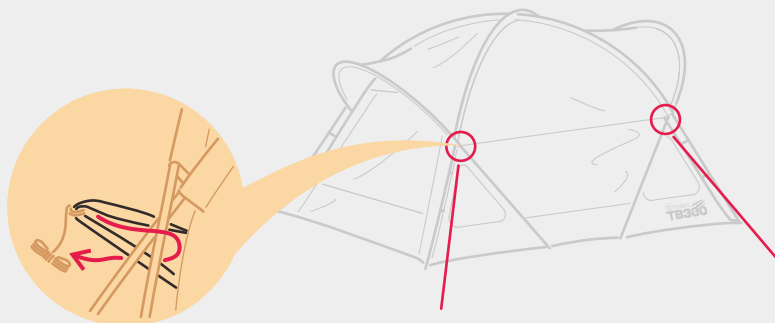

- 10** The W window top has three wind ropes, all staked down.

- 11** Each pole sleeve has two wind ropes, a total of eight places, all staked down.

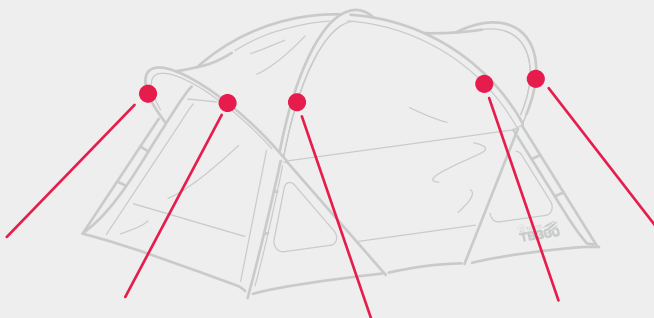

- 12 The side with the red elastic cord is the direction of the front door of the inner tent.

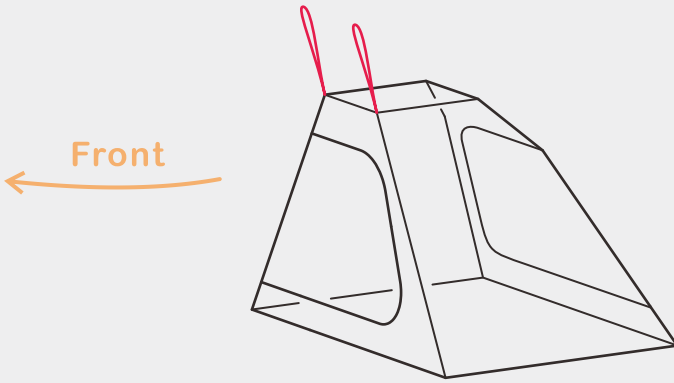

- 13 TB300 uses a symmetrical design and does not distinguish between front and back. After selecting the direction of the front door, first hang the red elastic cord, then fix the other hanging points on the back door, and finally fix the bottom hooks on the metal ring of the fork buckle to complete the installation.

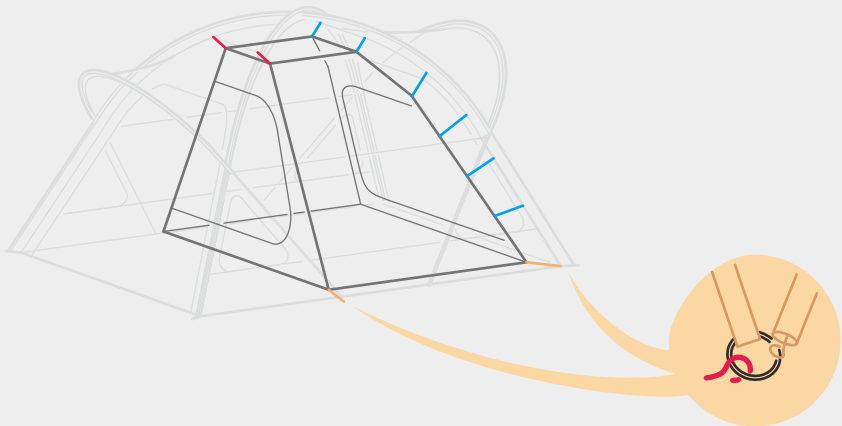

4.Space

Whether it's the tent door, T window, W window, or A window, they can all be opened to increase ventilation.

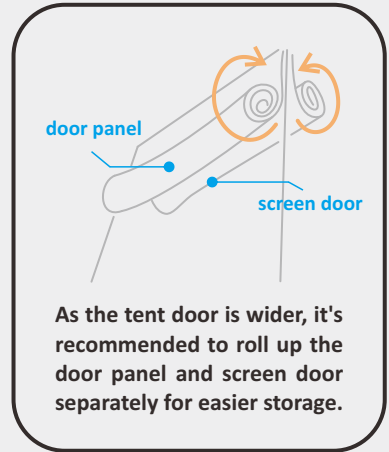

Hatchback models can directly position the rear of the car near the tent door and use it as a tailgate tent.

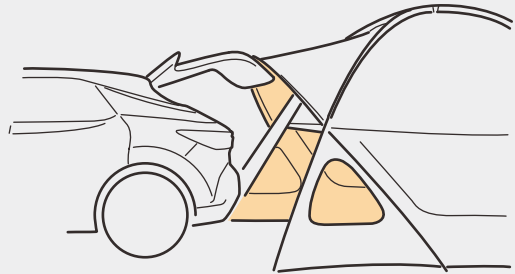

After using the inner tent, there is still a vestibule space available for use. The inner tent space is sufficient to accommodate four adults.

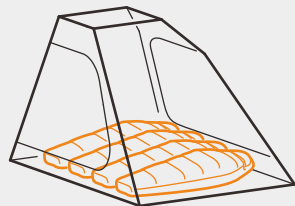
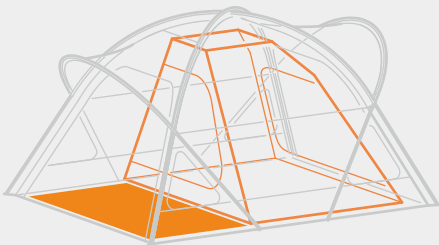

5. Pack away the tent

- 1 Spread out the outer tent, lift it at four points, and pull outwards at the midpoint on both sides (where the triangle is indicated).

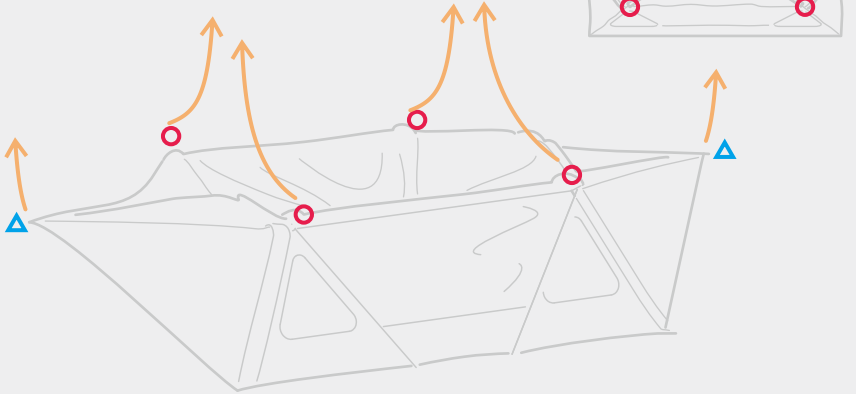

- 2 After lifting it, level it out and place it on the ground.

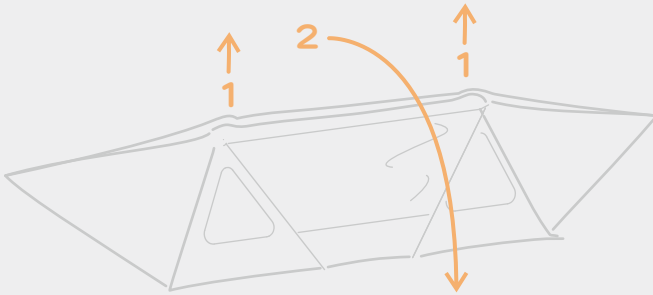

- 3 Fold both sides inward.

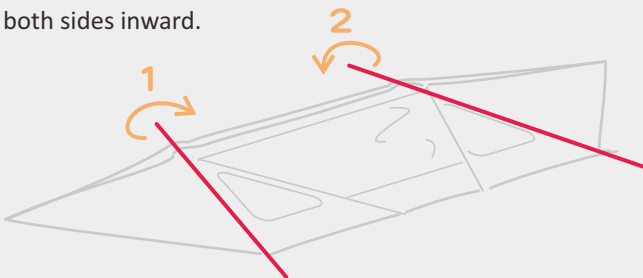

4 Fold inward again.

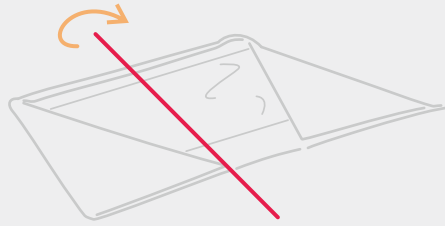

5 Fold again.

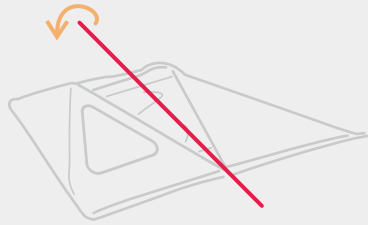

6 Fold.

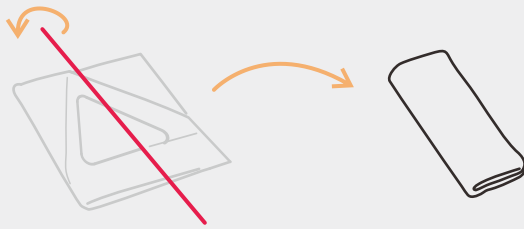

7 Place the inner tent.

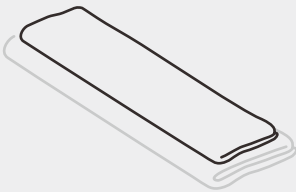

8 Roll up.

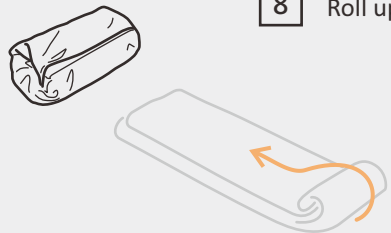

9 Pack it into the bag.

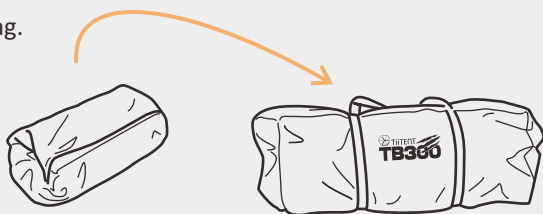

6 . Note

1. When using the product, make sure all pegs and wind-resistant guy lines are fastened so the tent can provide the best performance.
2. This product is not flame resistant. Do not light a fire inside the tent in case any irreversible or irreparable damage is caused. Be careful of fire, lack of oxygen, and carbon monoxide poisoning when using heaters in the tent. Please set up the tent in a location with good ventilation and drainage and without natural and manmade disasters.
3. Be aware of the weather. Please leave the campsite for a safe location in accordance to your evacuation plan if the weather gets bad. In the case of inclement weather or strong winds, please check your tent thoroughly to make sure all pegs and guy lines are fastened.
4. Before using the tent for the first time, please try to set up the tent and confirm the accessories and the steps for setting up the tent. To ensure the tent is used appropriately, please learn and understand how to use it. Please contact the vendor for any malfunctions.
5. When the temperature inside the tent is higher than the outside, water vapor will change into liquid water when it hits the wall of the flysheet and form droplets. This process is called condensation. Please keep the tent well ventilated to reduce this phenomenon.
6. The bottom end of the two rows of the door zipper is slightly unequal in length due to the manufacturing process. Do not pull the zipper too hard in case of damage.
7. Despite the good ventilation of the tent, it is not fully condensation-proof. Depending on the location of the site, condensation may occur inside the tent. Make sure the tent is properly ventilated.

Emergency Responses

With proper use and maintenance, the TiiTENT product can stay in good quality. Please be aware of the following important information to prevent damage to the product:

1. Accidents may damage the poles and fabric. Please bring repair kits (duct tape, guy lines, and tubes for reinforcements) with you at all times for immediate use.
2. If damage to the product is not fixed immediately, it may result in serious and even irreparable harm. If the fabric is torn or broken, please place duct tape over both sides of the fabric to prevent the damage from spreading or remove the damaged fabric.
3. Prolonged exposure to sunlight can cause colors to fade, weakening the strength of the fabric. Please bear in mind that the tent is not intended for use in prolonged settings in which they remain exposed to the sun. When the degradation caused by sunlight exceeds the endurance limit of the fabric, the damage will become permanent.
4. If the product is constantly damp, mold, stinky smells, color bleed, or fabric degradation may occur. Therefore, please make sure the product is fully dry before attempting to store it.
5. If the fabric becomes moldy due to humidity, the mildew might not be removed. However, please remove the mold on the surface and disinfect the fabric with alcohol. If the fabric is damaged by mold, leakage will occur.

Conditions Not Covered by our Warranty

Our products have undergone a rigid quality control process. Our warranty covers all the defects derived from errors during production; however, the following problems are not covered by our warranty.

Sorry for the inconvenience.

- 1. Damage caused by unexpected incidents.**
- 2. Damage due to improper use or undue force.**
- 3. Degradation of the materials over time or due to exposure to UV light.**
- 4. Damage caused by defects not associated with production.**
- 5. Damage from remodeling.**

If you have any questions regarding the warranty, please contact the retailer where you have bought the product from for after-sales services.



Tsair Yih Industrial Co., Ltd.
No.5, Xingye St., Xiaogang Dist.,
Kaohsiung City 812, Taiwan
service@tiitent.com
TEL:+886 7 8715879