



TIITENT®



PRO
TSR04P

4 SUNRISE

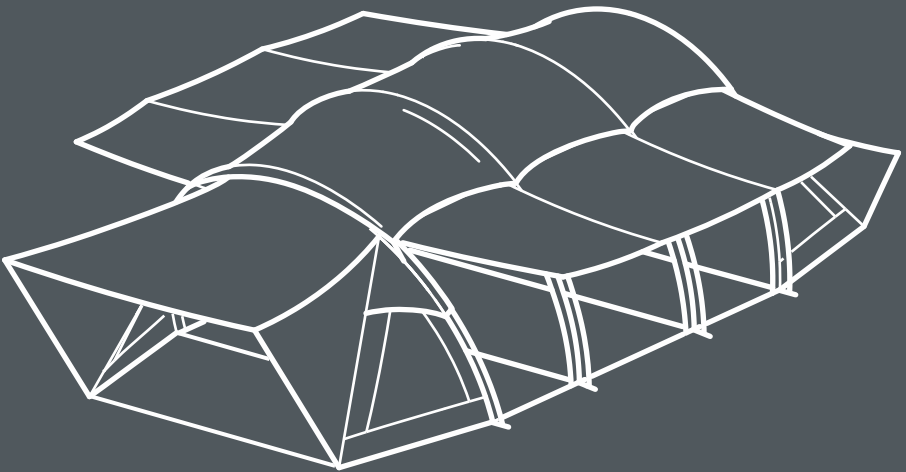

1. Content

4Sunrise PRO divided into two bags

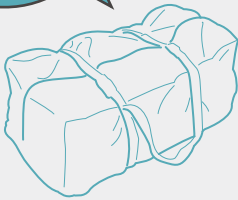

Outer tent X 1



Inner tent X 1



Flysheet X 1



Pole bag X 1



Peg set X 1



Pole bag contents



- Outside pole (16mm X2)
- Inside pole (19mm X2)
- Vestibule pole(X2)
- Back door pole(X2)
- Pole repair kit (16mm X1)
- Pole repair kit (19mm X1)

To prevent breakage, make sure that the pole joints are firmly connected before proceeding.

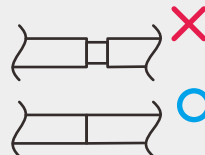

2. Dimension

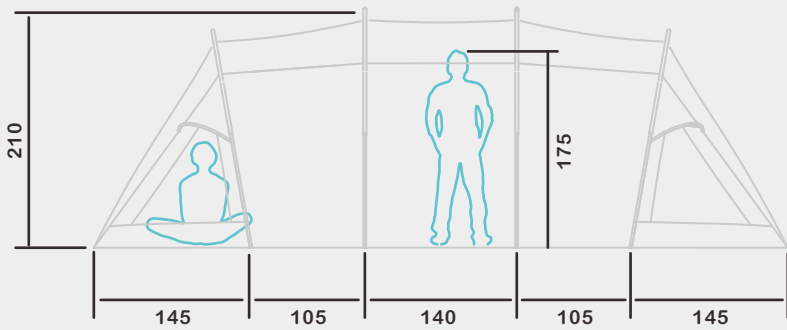
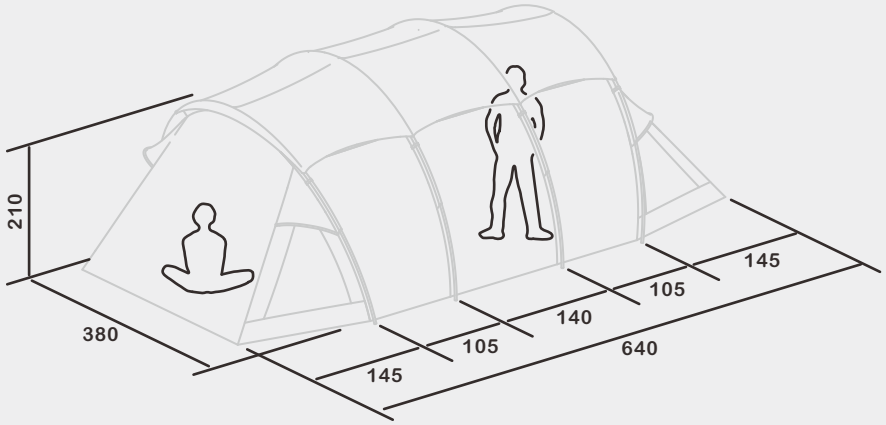

3. Set up the outer tent

Please set up the flysheet first

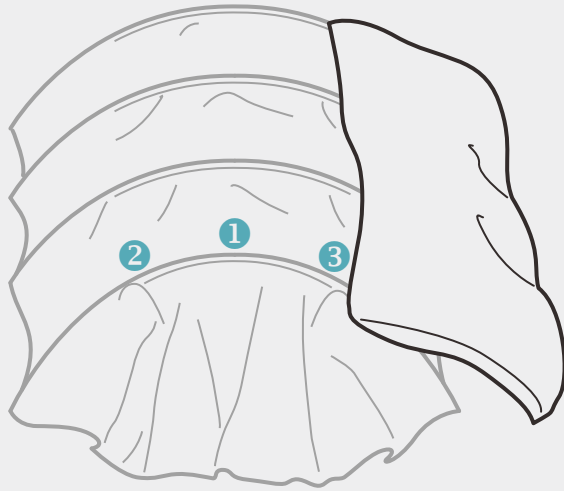

Before setting up, fix the flysheet on the outer tent.

There are three Velcro felts on the outside of the front and rear door sleeves, which can be fixed correspondingly to the flysheet. Please fix in order.

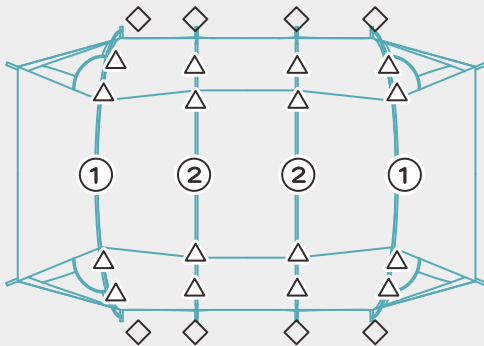

Note

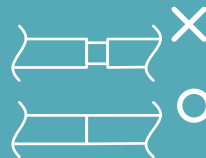

To prevent breakage, make sure that the pole joints are firmly connected before proceeding.



Be sure to loosen the webbing strap first, and then push the buckle into the pole.

- 1** Insert the outside pole (16mm) into the ① sleeve (black)



- 2** Insert the inside pole (19mm with red sticker) into the ② sleeve (red)

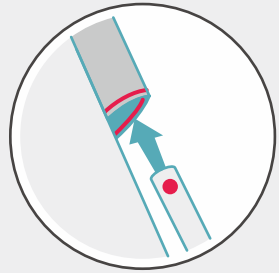

- 3** At the \diamond mark (8 places): Insert the pin of the ring & pin connector into one end of the pole. Bend the pole slightly into an arc shape and insert the other ring & pin connector into the other end of the pole.

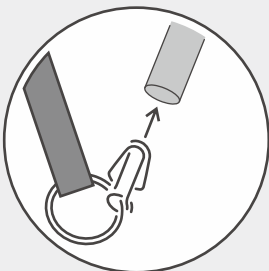

- 4** At the \triangle mark (16 places): Fasten the buckle to the pole.

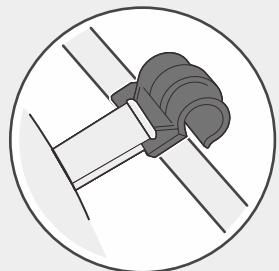

5

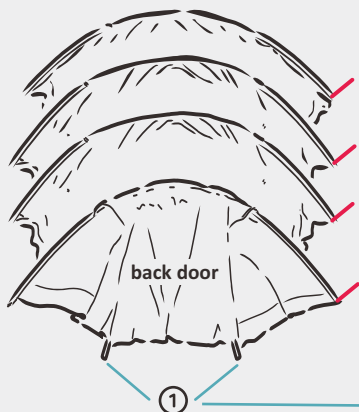

Note

Before propping up the tent, make sure all the buckles are securely fastened to the poles and the webbing strap is pulled taut. It can avoid damage to the poles caused by the instantaneous strong wind.



Stake the pegs into the ground at a 45-degree angle. Be careful when hammering in case you get hurt.

After the frame is fixed, the tent will be as shown as the figure below. Adjust the position of the tent and stake the webbing strap at ① into the ground.

6

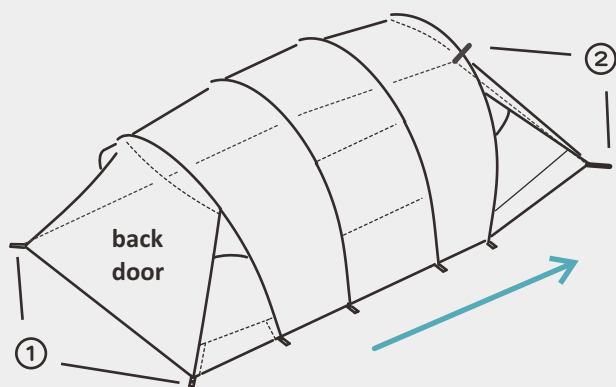

After the back door is secured, pull the front door away from the back door to form the tent shape. Pull tight the tent and stake the straps at the front door ② into the ground.

7

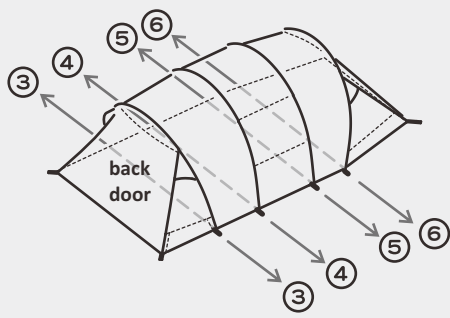

Flatten the tent and stake down at ③, ④, ⑤, and ⑥ in order

8

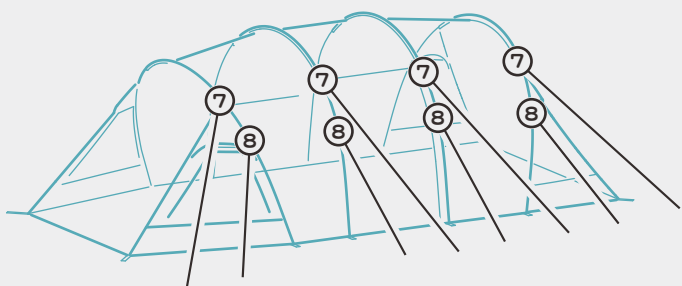

Fasten and tighten the windproof guy line ⑦ ⑧ (16 places)

Congratulations, your tent is set up!

The windproof guy line ⑧ is tied in a loop to enhance the wind resistance of the tent.

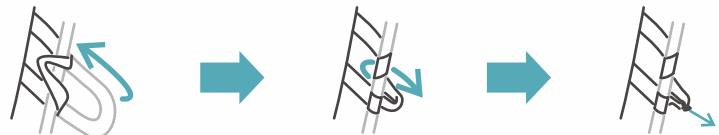

1. Wrap the webbing strap around the pole

2. Pull the front end of the webbing strap through the loop

3. Tie the guy line to the front end of the strap

Note

When packing away, please buckle up the positioning cords before pulling out the pegs. The poles can be dangerous if they bounce to the sides.

4. Tent Expansion

- 1 Use vestibule poles to prop the front door open

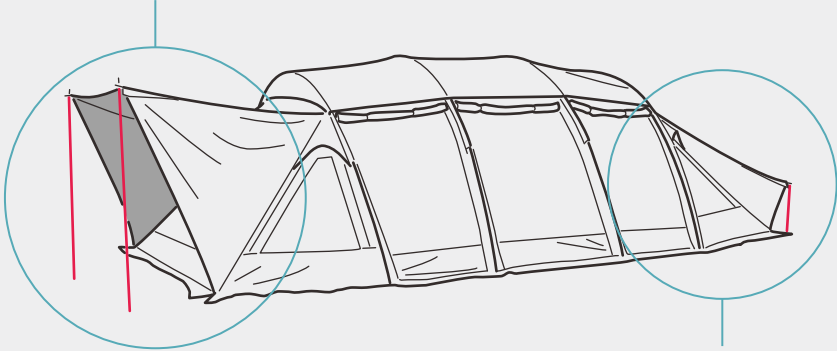

- 2 Use back door poles to prop the back door open

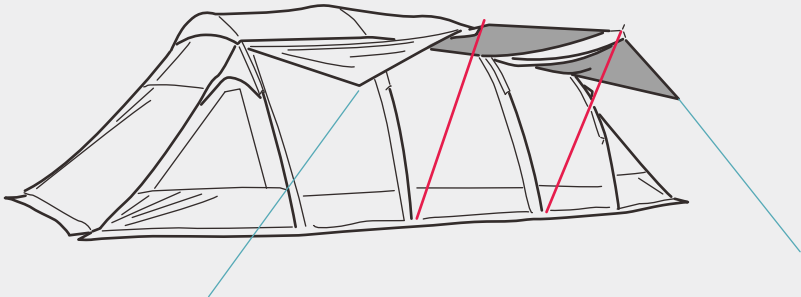

- 3 After using the vestibule poles to prop the middle side door, the left and right sides are connected with guy lines and then staked down.

5. Pack away the tent

Outer tent:

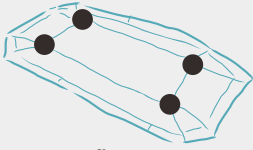

Lay the outer tent flat on the floor and pull up the four corners as shown in the figure.

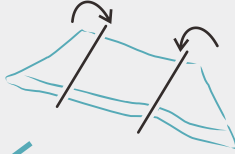
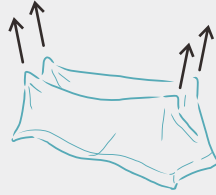

Fold it in half



Fold it in half again



Put it in the tent bag

inner tent:

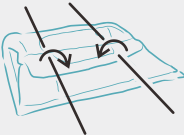

Lay the inner tent flat on the floor and fold towards the center as shown in the figure.



Divide it into three equal parts and fold the sides towards the center.



Fold it in half



Finish!

6. Space inside the tent

The inside of the tent consists of three parts as shown in the figure.

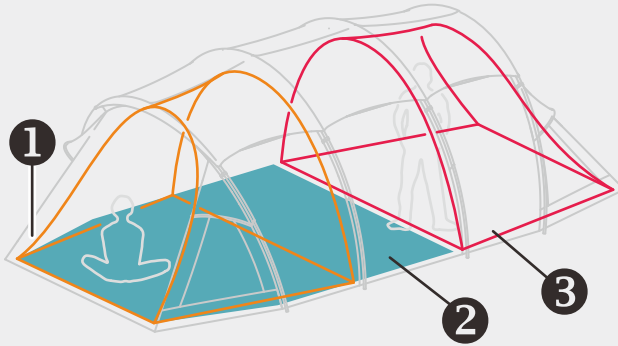

- ❶ The vestibule tent (sold separately):
increase sleeping area in the vestibule area
- ❷ Vestibule
- ❸ Inner tent

The inside of the vestibule tent:

Can easily accommodate 12 adults

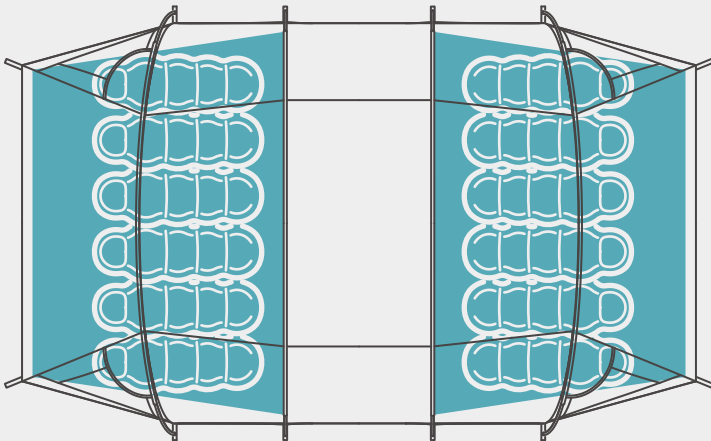

7. Notes

1. This tent is made of TC materials. During the initial uses, the tent must absorb moisture to help the internal fiber expand to bring out the best out of the fabric. If the fiber is not fully expanded initially, it may not provide expected waterproof performance and water may seep through the tent when raining, which is normal and will disappear after a few uses.
2. When using the product, make sure all pegs and wind-resistant guy lines are fastened so the tent can provide the best performance.
3. This product is not flame resistant. Do not light a fire inside the tent in case any irreversible or irreparable damage is caused. Be careful of fire, lack of oxygen, and carbon monoxide poisoning when using heaters in the tent. Please set up the tent in a location with good ventilation and drainage and without natural and manmade disasters.
4. Be aware of the weather. Please leave the campsite for a safe location in accordance to your evacuation plan if the weather gets bad. In the case of inclement weather or strong winds, please check your tent thoroughly to make sure all pegs and guy lines are fastened.
5. Before using the tent for the first time, please try to set up the tent and confirm the accessories and the steps for setting up the tent. To ensure the tent is used appropriately, please learn and understand how to use it. Please contact the vendor for any malfunctions.

6. Despite the good ventilation of the tent, it is not fully condensation-proof. Depending on the location of the site, condensation may occur inside the tent. Make sure the tent is properly ventilated.
7. Due to the color, thickness, and surface treatment of the fabric, wrinkles, uneven colors, knots caused by threads wound unevenly, white lines on the surface of the tape, or lines and indentation caused by folding may occur during manufacturing, which are normal and will not affect its functionality.
8. Due to the weaving methods of the fabric, there may be slight differences in colors between vertical and horizontal stripes in the sunlight which is normal and will not affect its functionality.
9. The TC fabric does not guarantee 100% water tightness because there is no water-proof tape on the seams.
10. If water seeps through the stitches or seams, you can enhance the tent using tent seam sealers sold on market.



T/C Mixed Cloth

- More delicate and soft touch
- Better heat and light prevention
- High breathability

This tent deploy tetoron and cotton mixed cloths (T/C Mixed Cloth) with soft touch and good heat/sunlight proof performance. The T/C mixed cloths also known as melamine sponge can absorb water with cotton fabric after multiple uses, making the texture more firm. With the water-repellent surface and light adhesive glue of the inner layer, the water resistance could reach 350mm~500mm, providing the best user experience.

The brand-new tent may have rain seepage because the cloths haven't reached the best performance. The new tents cannot support heavy rain at the very beginning, they are required multiple uses to achieve the best performance.

Emergency Responses

With proper use and maintenance, the TiiTENT product can stay in good quality. Please be aware of the following important information to prevent damage to the product:

1. Accidents may damage the poles and fabric. Please bring repair kits (duct tape, guy lines, and tubes for reinforcements) with you at all times for immediate use.
2. If damage to the product is not fixed immediately, it may result in serious and even irreparable harm. If the fabric is torn or broken, please place duct tape over both sides of the fabric to prevent the damage from spreading or remove the damaged fabric.
3. Prolonged exposure to sunlight can cause colors to fade, weakening the strength of the fabric. Please bear in mind that the tent is not intended for use in prolonged settings in which they remain exposed to the sun. When the degradation caused by sunlight exceeds the endurance limit of the fabric, the damage will become permanent.
4. If the product is constantly damp, mold, stinky smells, color bleed, or fabric degradation may occur. Therefore, please make sure the product is fully dry before attempting to store it.
5. If the fabric becomes moldy due to humidity, the mildew might not be removed. However, please remove the mold on the surface and disinfect the fabric with alcohol. If the fabric is damaged by mold, leakage will occur.

Conditions Not Covered by our Warranty

Our products have undergone a rigid quality control process. Our warranty covers all the defects derived from errors during production; however, the following problems are not covered by our warranty.

Sorry for the inconvenience.

- 1. Damage caused by unexpected incidents.**
- 2. Damage due to improper use or undue force.**
- 3. Degradation of the materials over time or due to exposure to UV light.**
- 4. Damage caused by defects not associated with production.**
- 5. Damage from remodeling.**

If you have any questions regarding the warranty, please contact the retailer where you have bought the product from for after-sales services.



Tsair Yih Industrial Co., Ltd.
No.5, Xingye St., Xiaogang Dist.,
Kaohsiung City 812, Taiwan
service@tiitent.com
TEL:+886 7 8715879