



TIITENT®

Muchatent

1. Content



MuchaTent

The package includes:



Tent X 1



Accessory pack X 1



Pole bag X 1



Guy line for tarp X 2



Guy line X 6



Peg X 10



Lightning cap X 6

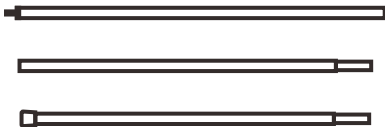

Long pole (3 Section) X 2



Short pole X 4

2. Dimension

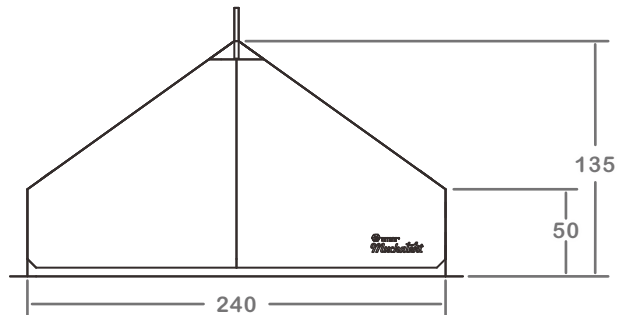
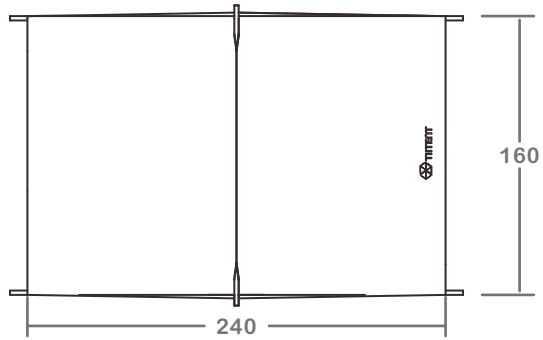
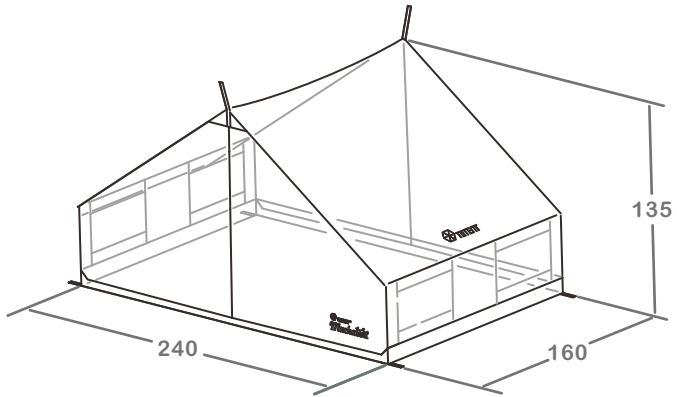

3. Set up the tent

The MuchaTent can be used with or without a tarp.
Below are the instructions for setting up the tent.

Direction of the door

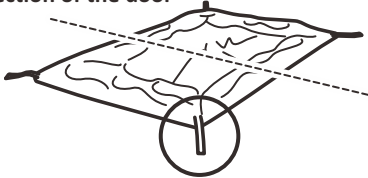

1. After deciding the location for the tent, spread the four corners out and pull the webbing straps at the four corners to the pegging points; then stake the straps down through A (the distance between A and C is 30cm).

***If you want to set up the tent under a tarp, please align the dotted line to the middle line (ridge) of the tarp.**

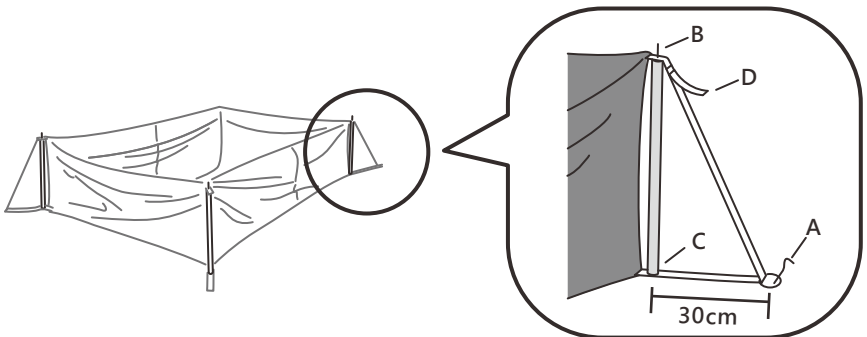
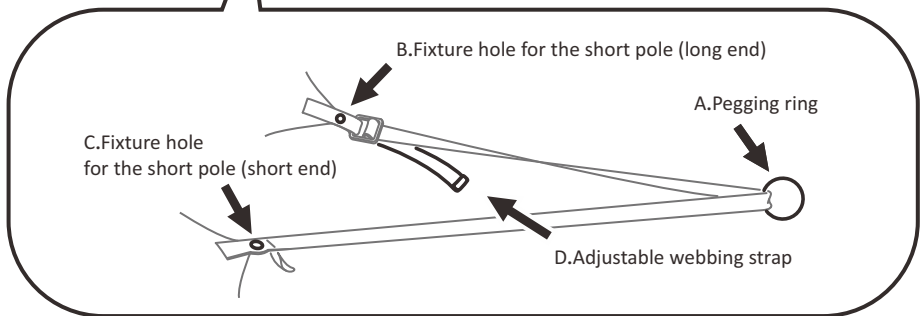

2. Prop up the four corners one by one. Insert the long thin end of the short pole through the fixture hole of B and the short thin end through the fixture hole of C. Then pull D and adjust it to the right tightness.

Below are the instructions for setting up the tent without and with a tarp (please turn to next page).

Used without a tarp:

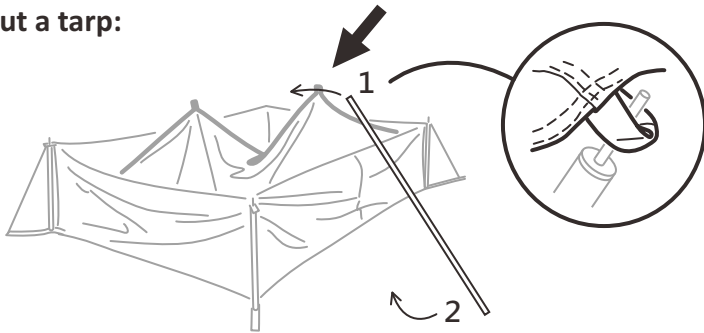

3. Pull up the webbing strap on top of the front door, insert the long pole through the loop of the webbing strap, and then erect the pole. Perform the same step for the other side.

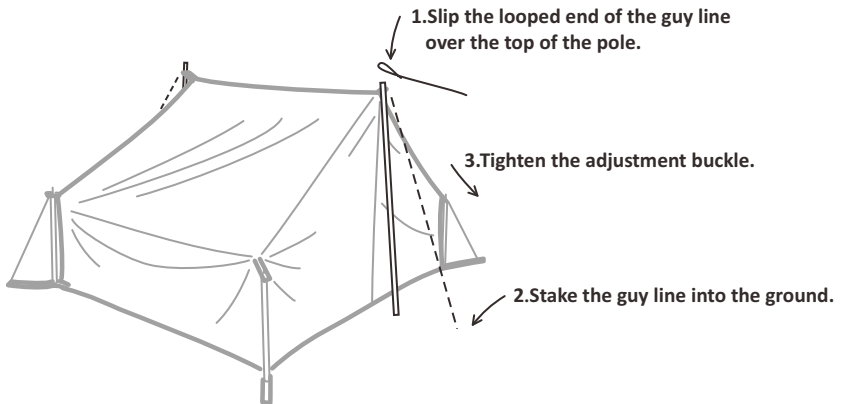

4. Slip the guy line over the top of the pole, stake the guy line into the ground, and tighten the adjustment buckle. Perform the same step for the other side *(You can place a lightning cap on top of the pole).

The MuchaTent without a tarp is now set up.

Used with a tarp:

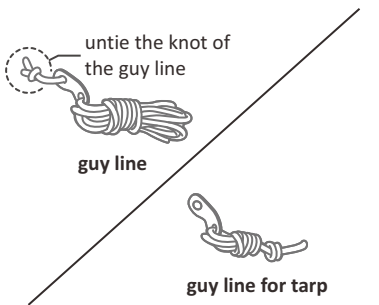

3. Have the guy line and the pull cord for the tarp ready.

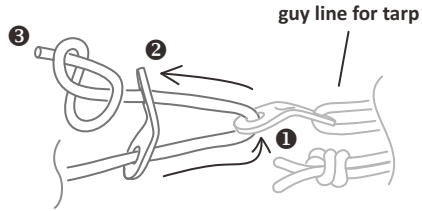

4. After untying the knot of the guy line, thread the working end **1** through the pull cord of the tarp and **2** back to the adjustment piece on the guy line. Then tie a knot at the end **3**.

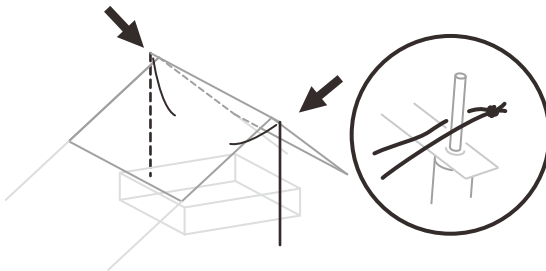

5. Fasten one end of the pull cord to the pole of the tarp.

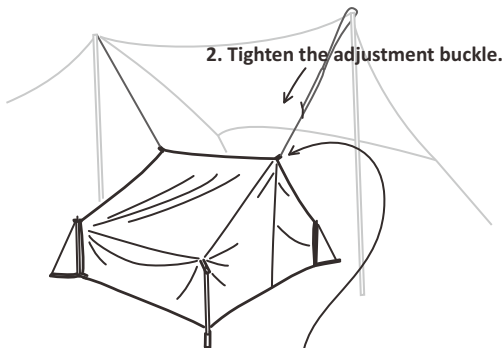

1. Tie the guy line for the tarp to the webbing strap at the top of the tent's door.

6. Tie the webbing strap at the top of the tent's door to the guy line for the tarp and tighten the adjustment buckle. Perform the same step for the other side.

***You can place a lightning cap on top of the pole.**

The MuchaTent with a tarp is now set up.

4. Space

MuchaTent internal accommodation

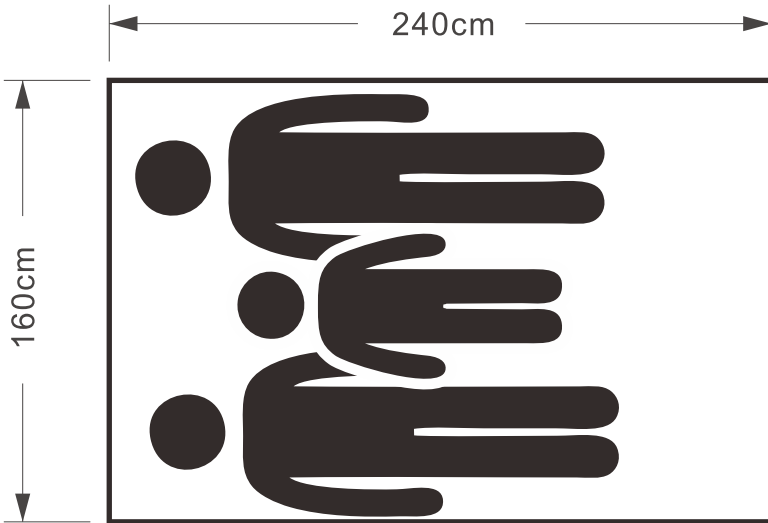

The space of the inner tent is 240x160cm
Can easily accommodate 2 adults and 1 child

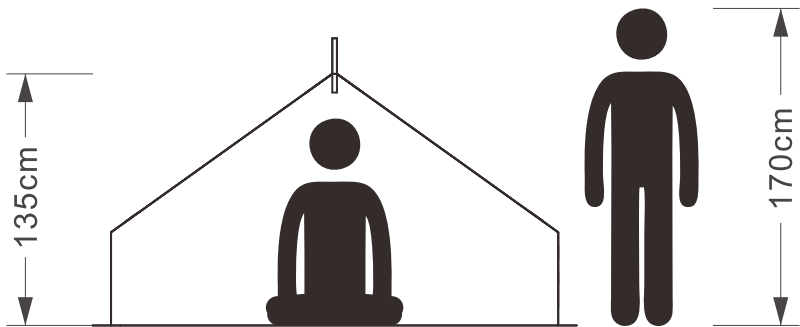

Height scale

Use of the skirt:

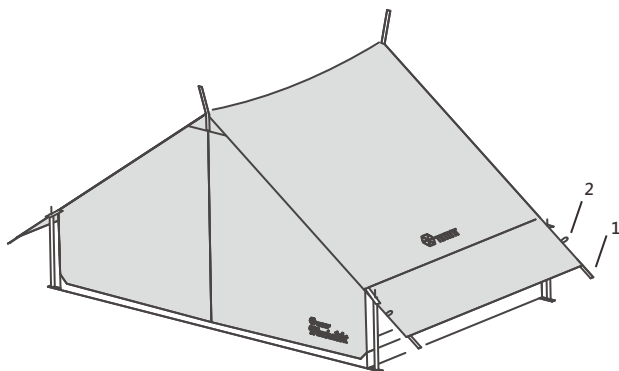

There are two webbing strap rings on the edge of the skirt: Ring 1 and Ring 2. Hook the rings over the top of the short pole to adjust the opening of the side windows.

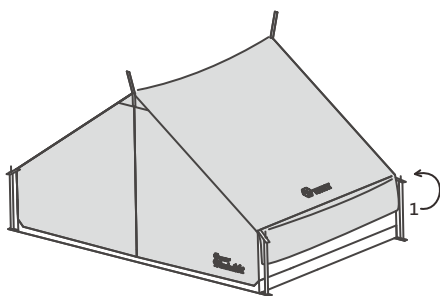

First part: Hook Ring 1

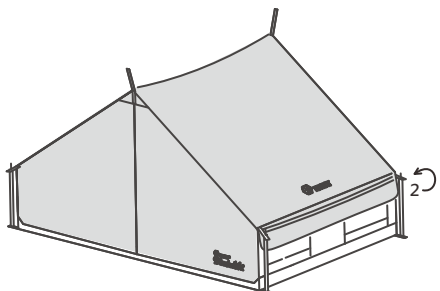

Second part: Hook Ring 2

5. Pack away the tent

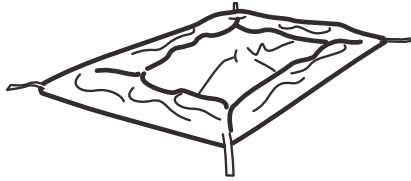

1. Lay the tent flat on the ground

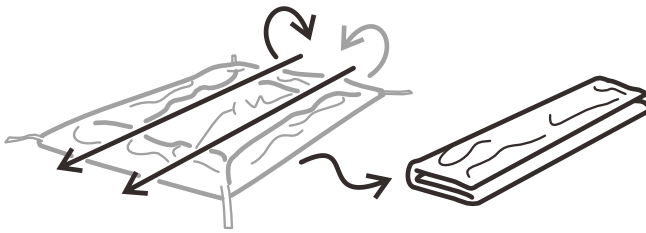

2. Divide it into three equal parts and fold the outer sides toward the center.

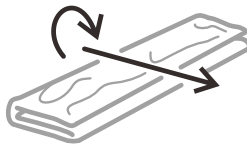

3. Then fold it in half.

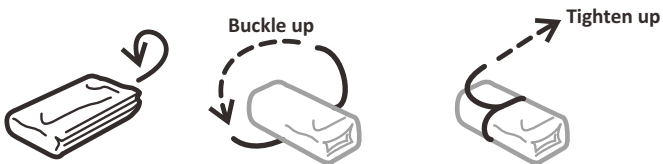

4. Roll the tent up and secure the rolled tent with the strap buckle. Tighten the strap and put the tent away.

6. Notes

1. The MuchaTent is made of TC materials. During the initial uses, the tent must absorb moisture to help the internal fiber expand to bring out the best out of the fabric. If the fiber is not fully expanded initially, it may not provide expected waterproof performance and water may seep through the tent when raining, which is normal and will disappear after a few uses.
2. When using the product, make sure all pegs and wind-resistant guy lines are fastened so the tent can provide the best performance.
3. This product is not flame resistant. Do not light a fire inside the tent in case any irreversible or irreparable damage is caused. Be careful of fire, lack of oxygen, and carbon monoxide poisoning when using heaters in the tent. Please set up the tent in a location with good ventilation and drainage and without natural and manmade disasters.
4. Be aware of the weather. Please leave the campsite for a safe location in accordance to your evacuation plan if the weather gets bad. In the case of inclement weather or strong winds, please check your tent thoroughly to make sure all pegs and guy lines are fastened.
5. Before using the tent for the first time, please try to set up the tent and confirm the accessories and the steps for setting up the tent. To ensure the tent is used appropriately, please learn and understand how to use it. Please contact the vendor for any malfunctions.

6. Despite the good ventilation of the tent, it is not fully condensation-proof. Depending on the location of the site, condensation may occur inside the tent. Make sure the tent is properly ventilated.
7. Due to the color, thickness, and surface treatment of the fabric, wrinkles, uneven colors, knots caused by threads wound unevenly, white lines on the surface of the tape, or lines and indentation caused by folding may occur during manufacturing, which are normal and will not affect its functionality.
8. Due to the weaving methods of the fabric, there may be slight differences in colors between vertical and horizontal stripes in the sunlight which is normal and will not affect its functionality.
9. The TC fabric does not guarantee 100% water tightness because there is no water-proof tape on the seams.
10. If water seeps through the stitches or seams, you can enhance the tent using tent seam sealers sold on market.

Emergency Responses

With proper use and maintenance, the TiiTENT product can stay in good quality. Please be aware of the following important information to prevent damage to the product:

1. Accidents may damage the poles and fabric. Please bring repair kits (duct tape, guy lines, and tubes for reinforcements) with you at all times for immediate use.
2. If damage to the product is not fixed immediately, it may result in serious and even irreparable harm. If the fabric is torn or broken, please place duct tape over both sides of the fabric to prevent the damage from spreading or remove the damaged fabric.
3. Prolonged exposure to sunlight can cause colors to fade, weakening the strength of the fabric. Please bear in mind that the tent is not intended for use in prolonged settings in which they remain exposed to the sun. When the degradation caused by sunlight exceeds the endurance limit of the fabric, the damage will become permanent.
4. If the product is constantly damp, mold, stinky smells, color bleed, or fabric degradation may occur. Therefore, please make sure the product is fully dry before attempting to store it.
5. If the fabric becomes moldy due to humidity, the mildew might not be removed. However, please remove the mold on the surface and disinfect the fabric with alcohol. If the fabric is damaged by mold, leakage will occur.



T/C Mixed Cloth

- More delicate and soft touch
- Better heat and light prevention
- High breathability

This tent deploy tetoron and cotton mixed cloths (T/C Mixed Cloth) with soft touch and good heat/sunlight proof performance. The T/C mixed cloths also known as melamine sponge can absorb water with cotton fabric after multiple uses, making the texture more firm. With the water-repellent surface and light adhesive glue of the inner layer, the water resistance could reach 350mm~500mm, providing the best user experience.

The brand-new tent may have rain seepage because the cloths haven't reached the best performance. The new tents cannot support heavy rain at the very beginning, they are required multiple uses to achieve the best performance.

Conditions Not Covered by our Warranty

Our products have undergone a rigid quality control process. Our warranty covers all the defects derived from errors during production; however, the following problems are not covered by our warranty.

Sorry for the inconvenience.

- 1. Damage caused by unexpected incidents.**
- 2. Damage due to improper use or undue force.**
- 3. Degradation of the materials over time or due to exposure to UV light.**
- 4. Damage caused by defects not associated with production.**
- 5. Damage from remodeling.**

If you have any questions regarding the warranty, please contact the retailer where you have bought the product from for after-sales services.



TIITENT

Video for pack away the tent



Video for setting up the tent



Tsair Yih Industrial Co., Ltd.
No.5, Xingye St., Xiaogang Dist.,
Kaohsiung City 812, Taiwan
service@tiitent.com
TEL:+886 7 8715879